



THE INDEPENDENCE[®]
BY CUSTOMATIC[®] TECHNOLOGIES
THE BED THAT LIFTS YOU[™]



Owner's Manual

Serial Number

(Place your serial number here for ready reference)

Model Number: CUSIN01

LEGAL NOTICES / INTELLECTUAL PROPERTY

Independence Beds, Inc. is the exclusive authorized reseller of The Independence® Bed by Customatic Technologies™, another innovative bedding product by PPJ, LLC, dba Customatic Technologies ("PPJ").

PPJ is the owner of the patents listed below, copyright in respect to this user manual, as well as the following trademarks which are licensed to Independence Beds, Inc. in connection with these products: Independence®, The Independence®, Customatic®, Customatic Technologies™, THE BED THAT LIFTS YOU™ and the following trademarks:



This product and all our bedding products are covered by one or more of the following issued and pending U.S. patents including Nos. 15/909,407, 7448100, D657157, D663542, D657158, D657156, 8209801, 8209800, D663544, D663543 and other patents pending.

Photos are for illustration purposes only.

COPYRIGHT © 2022 CUSTOMATIC®

IF YOU EXPERIENCE ANY TROUBLE WITH YOUR INDEPENDENCE BED WITHIN THE WARRANTY PERIOD, PLEASE CONSULT THE TROUBLESHOOTING GUIDE PROVIDED WITH YOUR BED AND ONLINE, IF APPLICABLE. IF PROBLEMS PERSIST, PLEASE CALL:

CUSTOMER SERVICE NUMBER

1 (844) 815 9023

TheIndependenceBed.com

TABLE OF CONTENTS

Safety Precautions	4
Parts List	6
Installation Guide	7
Wired Remote Control Guide	15
Special Functions	17
Troubleshooting	18
Warranty and Registration	22

Safety Precautions

ATTENTION!

IMPORTANT SAFETY INSTRUCTIONS.

PLEASE READ THESE INSTRUCTIONS THOROUGHLY BEFORE USING THIS PRODUCT.



ELECTRICAL SAFETY

Always unplug this Independence bed from the electrical outlet before any cleaning or maintenance of the bed. To safely disconnect, make sure all controls are in the off position, then remove the plug from the outlet.

Keep cord away from heated surfaces. Keep air openings free of lint, hair and the like. Never operate when air openings are blocked. Never drop or insert any object into any opening. Use only indoors.

Cease use of this Independence bed and contact the Customer Care Center for repair if: (1) it has a damaged cord or plug, (2) it is not working properly, (3) it has been dropped or damaged, or (4) it has been dropped into water.

GROUNDING SAFETY

To reduce the risk of electric shock, electrical fire, or faulty operation of this product, your Independence bed may feature a polarized plug meant to be used only with a grounded electrical outlet. If this plug does not fit into your outlet, contact a qualified electrician to install a properly grounded outlet. Failure to use a properly grounded outlet for this product will compromise this important grounding safety feature. The use of adapters is not recommended unless the outlet is checked by a qualified electrician to ensure the proper grounding of the adapter.

NOTE: Unauthorized modifications to this product could void the electrical portion of your warranty.

WARRANTY WARNING!

This Independence bed is specifically designed to require no maintenance by you, the user. Any opening or tampering with the control box, motors, or hand controls (with the exception of the battery compartment if equipped) will result in a void of the warranty. Only those authorized may conduct repairs or part replacement on your Independence bed. Unauthorized modifications to this product could void the electrical portion of your warranty.

MATTRESS PROTECTOR: We strongly recommend using a mattress protector (not included) to protect your Independence bed

mattress from spills, stains, and fluids which are not covered under the warranty.

IN-HOME USE ONLY

This Independence bed is designed exclusively for in-home use.

HOSPITAL DISCLAIMER: It is NOT designed for hospital use and is NOT designed to meet hospital standards. Do not use this bed with TENT TYPE oxygen therapy equipment or use near explosive gases.

IMPORTANT SAFETY FEATURES

Weight fail safe feature: In the case that an overload of weight is placed on the head or foot mechanism, the control unit will automatically stop all functions. The control unit will automatically resume all functions 30 seconds after excess weight is removed.

The recommended weight limitations for your Independence bed is up to 500 lbs.

For your Independence bed to structurally support the recommended weight, weight must be distributed evenly across the head and foot sections. The Independence bed will not and is not intended to support or lift this amount in just the head or foot section. Dependent on the size and/or model of mattress, the available weight limit may be less.

The structure of the Independence bed will support the recommended weight when distributed evenly across the bed. The head and foot sections are not designed to individually support or lift this amount of weight. For optimal performance, entering and exiting the Independence bed with the bed in the flat or level position is recommended.

NOTE: Exceeding the recommended weight restrictions could damage your Independence bed and void your warranty.

If your adjustable bed is positioned on a hard floor surface such as hardwood or tile, it is recommended that rubber cups or carpet squares are placed under the legs to prevent damaging or



FOR OPTIMAL SAFETY, YOUR INDEPENDENCE BED SHOULD BE PLUGGED INTO A SURGE PROTECTOR (not supplied with this Independence bed).

Safety Precautions

scratching your floor.

USER-SERVICEABLE PARTS

This Independence bed is specifically designed to have no maintenance by you, the user. Therefore, you are encouraged not to open any motors, alter the wiring, or adjust, modify or change the structure of the product, as it will void the warranty.

FCC compliant device complies with part 15 of the FCC Rules. Operation is subject to the following two conditions: (1) This device may not cause harmful interference, and (2) this device must accept any interference received, including interference that may cause undesired operation.

IMPORTANT NOTE: To comply with the FCC RF exposure compliance requirements, no change to the antenna or the device is permitted. Any change to the antenna or the device could result in the device exceeding the RF exposure requirements and void user's authority to operate the device.



CONSUMERS WITH PACEMAKERS

It is possible that the (optional) vibrating feature of this Independence bed may be misinterpreted by some pacemakers as movement and/or exercise. This is common with any product that produces a vibrating motion, and may or may not affect your pacemaker. Please consult your physician with any concerns.

PRODUCT RATINGS

Lift Motor Restrictions: The lift motors in the Independence bed are NOT designed to operate continuously for more than three (3) minutes over a thirty (30) minute time period, or approximately 10% duty cycle. To ensure reliable functionality and full life of this product, do not attempt to exceed these limits.

NOTE: Attempting to circumvent or exceed this rating will shorten the life expectancy of the product and may void the warranty.



SMALL CHILDREN AND PETS WARNING

Immediately dispose of all packing materials as it can pose a smother risk to small children and pets. Injury could occur also if children or pets are permitted to play on or under the bed. Do not

allow children to operate this bed without adult supervision.

LIFT WARNING

Do not sit on the head or foot sections while in the raised position, or during lift or lowering cycles.

MOVING AFTER INSTALLATION

Do not place Independence bed vertically on its head or foot sections. This may cause injury to persons or damage to the Independence bed. Two people are required for moving this Independence bed due to its heavy weight.

SAFETY

The input transformer voltage is AC 120V 60HZ; the output voltage is DC24V 3A. In case of an output short circuit, the power supply will shut down safely. If this occurs, please contact Customer Care Center for proper troubleshooting and assistance returning your base to operational condition.

NOTICE: The changes or modifications not expressly approved by the party responsible for compliance could void the user's authority to operate the equipment.

When the Independence bed is in Stand position and you are exiting the bed, keep all linens and pillows away from your feet to avoid entanglement.

The Independence bed includes several safety features to limit risks associated with the product. These safety features include a motor detection feature. When a lift or rotation motor is unplugged or is not securely connected to the control box or fails to function properly, the bed will not operate for safety reasons.

When any error detection issue is resolved, the system needs to undergo a power reset before it can operate normally as a safety feature. For more information, read the Troubleshooting section of this manual.

Read the Owner's Manual carefully and completely before operating the product. Electric shock may occur if electrical components are not installed or operated according to these guidelines.

SAVE THESE INSTRUCTIONS.

Proper operation of your Independence bed is necessary to ensure the long life and durability you expect from a high-quality product. The manufacturer has tested and inspected this product prior to shipment.

Parts List

Before discarding any packing materials, check the Independence bed carton and make sure all items in the parts list are included.



Wired remote control (1)**



Post bed leg (4)



Knob screw (6)*



Spring washer (4)*



Arm (2)



Mattress (1)



Mattress retainer (1) ***



Arm bracket with spring release (2)**



Bolt (2)****



Washer (2)****



Nut (2)****



Wrench (1)



Allen key wrench (1)

* Four (4) knob screws with four (4) spring washers are attached to the base. Two (2) knob screws are attached to the arm bars on the Independence bed.

** Part is tied to the frame during shipment.

*** Mattress bracket is located in the top carton.

**** Bolts, washers, and nuts are for the arm assembly.

Installation Guide

IMPORTANT!

- For safety reasons, the Independence bed must always be lifted by two (2) people; and the unit should always be on a flat surface before opening.
- By default, your Independence bed is set to turn to the LEFT side of the person lying on it (or to the RIGHT side of the person standing at the foot of the bed facing it). To change the Independence bed to turn the other way, setup your bed, and then see the instructions to change the bed rotation in the later pages of the manual.

SETTING UP YOUR INDEPENDENCE BED

Setting up the bottom part of the bed

- 1** Open the shipping carton containing the bottom part of the bed and remove any smaller accessory boxes.
- 2** Cut the orange and white zip ties to remove the parts that are tied to the bed during shipment.
- 3** Take out the four (4) post bed legs from the accessory box.
- 4** Attach all the bed legs by threading them in a clockwise direction into the pre-drilled holes on the frame.
NOTE: Do not overtighten the bed legs.



- 5** Lift the bottom part of the bed on its side and then turn it over carefully.
NOTE: Do not rest the frame on its side. The weight may damage the legs.
- 6** Place the bottom part on a flat and stable surface with the top side now facing up. Remove the shipping carton and plastic.



Installation Guide

Setting up the top part of the bed

- 1 Open the shipping carton containing the top part of the bed and remove any smaller accessory boxes. Remove the strap holding the mattress bed retainer from under the top part of the bed. **NOTE:** Take note of the mattress retainer. You will use it later in the setup.
- 2 Cut the orange and white zip ties to remove the arm brackets that are tied to the bed during shipment.
- 3 Lift the top part on its side and turn it over carefully.
- 4 With two people holding the bed in the middle, lift it out of the shipping carton and place it over the bottom part of the bed.

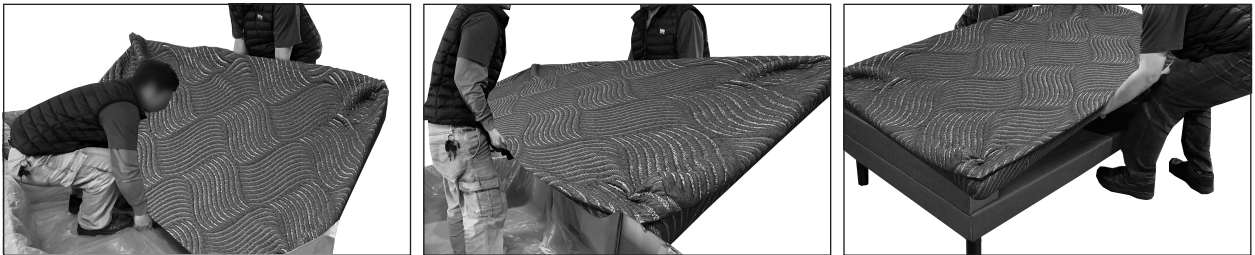

NOTES:

- Make sure the top part is aligned with the bottom part of the bed.
- The top and bottom parts have foot stickers (see red arrows below) to indicate the foot section of the bed. Make sure the foot section of the top part of the bed aligns with the foot section of the bottom part.
- Make sure the holes on both parts (see black arrows below) align properly with each other.
- The top part of the Independence bed does not lock in place when it is installed the wrong way.

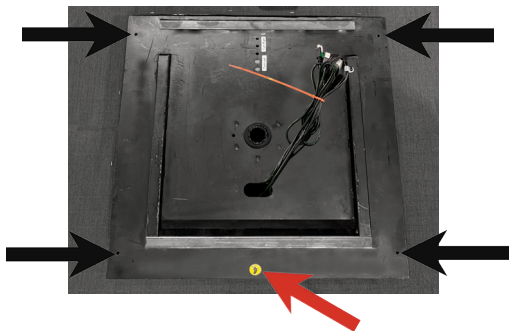

Bottom part of the bed

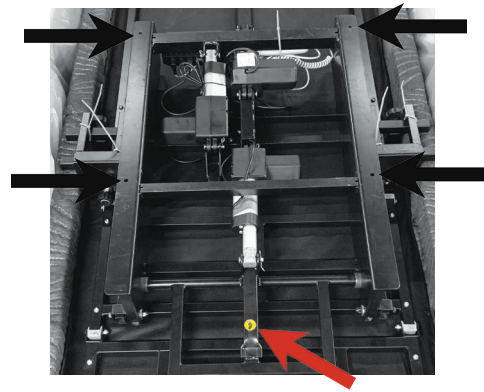

Top part of the bed

- 4 Secure the top part to the bottom part of the Independence bed by threading the four (4) knob screws fitted with spring washers into the pre-drilled holes on both sides of the bed.

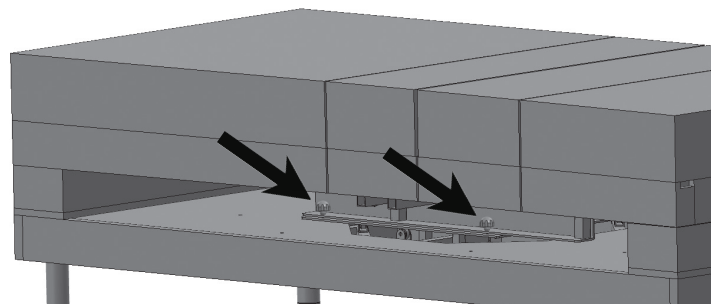

Installation Guide

Setting up the bed mattress and attaching the mattress retainer

- 1 Open the shipping carton containing the bed mattress and take out the bed mattress.
- 2 Unzip the mattress cover to access the "loop" retainer anchors. **NOTE:** Keep the mattress cover open.
- 3 Align the open ends of the retainer bar with the "loop" retainer anchors located at the foot of the bed.
- 4 Slide the retainer bar into the anchors allowing the ends to glide into the loop.



- 4 Cut the plastic casing of the bed mattress carefully.
- 5 Unroll the bed mattress and remove the plastic casing completely.



- 6 With the mattress cover still open, insert the bed mattress.
- 7 Make sure the bed mattress fits well inside the mattress cover. Close the zippers of the mattress cover.

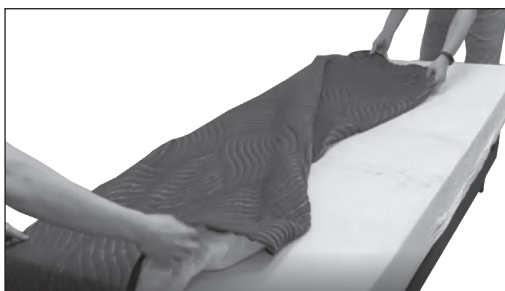

Installation Guide

SETTING UP THE ELECTRONICS

- 1 Lift the head section of the Independence bed manually to access the control box.

NOTE: One assembly personnel can hold the head section up to allow the other personnel to access the control box.

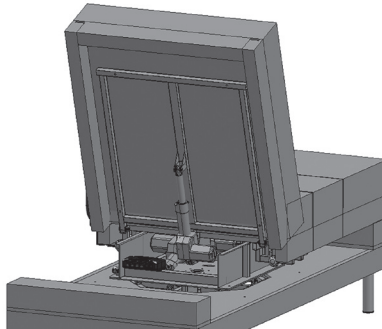

- 2 Cut the zip tie holding the rotation motor cable, DC power cable, and the two USB cables to the bottom part.

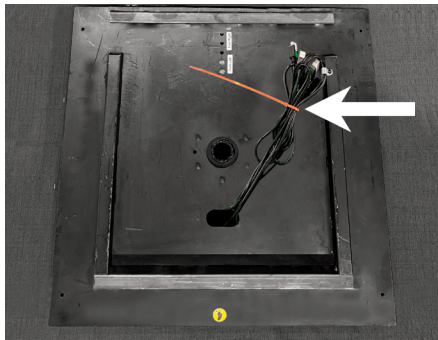

- 3 Plug the rotation motor cable to the port labeled "ROTATE MOTOR" on the control box. Then, make sure the wired remote control is properly plugged into the port labeled "HANDSET".

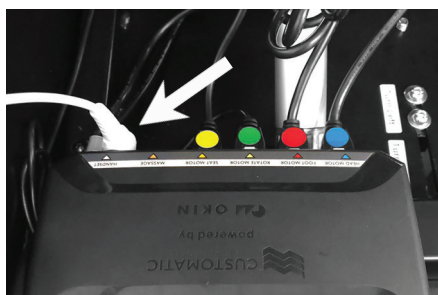
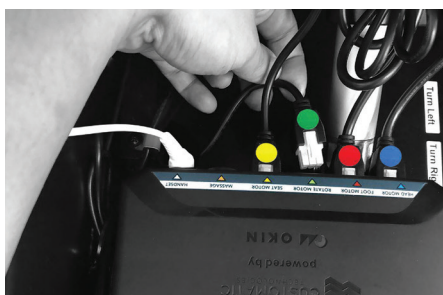

- 4 Plug the power cable to the port labeled "POWER" on the control box.



IMPORTANT!
Make sure all the motor and power cables are properly plugged into the control box. Push the cables into their ports until you hear a *click*.

Installation Guide

- 5 Plug the two USB cables to the ports with the USB icon on the control box.

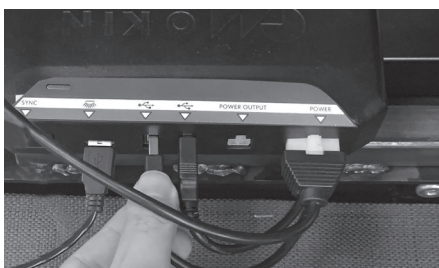

- 6 Lower the head section of the Independence bed carefully.

NOTE: Make sure cables do not obstruct any Independence bed mechanisms.

- 7 Plug the power cord into a working electrical outlet.
The LED on the remote blinks slowly indicating a system reset is needed.

NOTE: For optimal safety, using a surge protector (not included) is highly recommended.

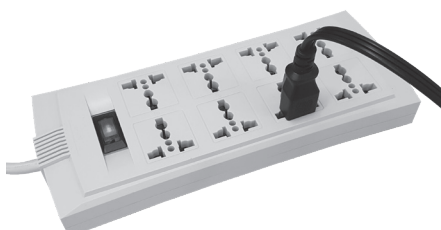

- 8 Reset the system to activate the Independence bed functions. On your wired remote control, press the **Seat Down** button three (3) times quickly. The bed moves into a flat position and the system resets.

- 9 Try all functions on the wired remote control to make sure all functions are working properly.

NOTE: Some buttons may not function if the Independence bed is not in the correct mode or position. For information on using the wired remote control, see the "Wired Remote Control Guide" on page 16.

IMPORTANT! If power is removed or when a power failure occurs while the Independence bed is in operation or it is not in a flat position, make sure to return the bed into a flat position as soon as power is restored. This is required to restore the correct position and operation of the motors for safety. On your wired remote control, press the **Seat Down** button 3 times quickly.

NOTE: By default, the Independence bed rotates to the left. You can change the direction of the rotation to the right by moving the rotation motor and the rotation stopper. For more information, see "Changing the direction of the bed rotation" on page 13. If you do not plan to make changes to the bed rotation, proceed to "Installing the arm rests" on page 14.

Installation Guide

CHANGING THE DIRECTION OF THE BED ROTATION

By default, the Independence bed rotates to the left side of the user lying on the bed. The rotation motor is placed on the bracket with the label "Turn Left". To change the direction of the rotation to the right, do the following after setting up your Independence bed.

NOTE: The tools needed to change the bed rotation are placed in the accessory box with the armrests. The accessory box is in the shipping carton containing the top part of the Independence bed.

- 1 After setting up your Independence bed, release the rotation motor first.
 - a. Make sure the bed is still connected to the AC power.
 - b. Press the **Rotate Stand** button on the wired remote control.
 - c. Allow the bed to rotate for three (3) seconds before releasing the Rotate Stand button.
- 2 Separate the top part from the bottom part of the Independence bed with the head and foot sections still raised.
 - a. Unplug the AC outlet for safety.
 - b. Remove the four (4) knob screws that connect the top and bottom parts of the bed.
 - c. Unplug the rotation motor cable, DC power cable, and USB cables from the control box.
 - d. Lift the top part from the bottom part and place it on a flat surface.
- 3 On the metal plate of the bottom part, locate the stopper that controls the rotation of the Independence bed. Using an Allen key wrench, loosen the screws.

NOTE: Do NOT move the stopper yet. Simply loosen the bolts.

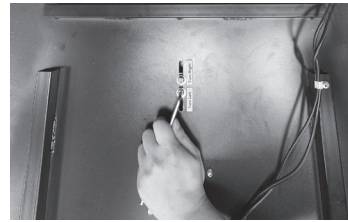
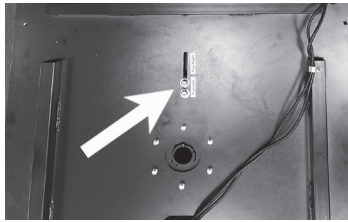

- 4 Turn the Independence bed over to its side carefully, and then locate the rotation motor.

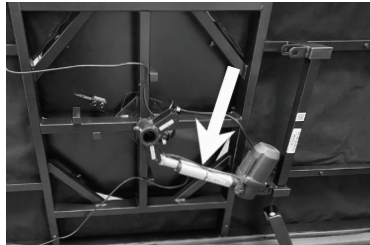

- 5 On one end of the motor, remove the cotter pin from the motor pin holding the motor to the bed frame. Remove the motor pin. Do the same on the other end of the rotation motor. Detach the rotation motor from the bottom part.

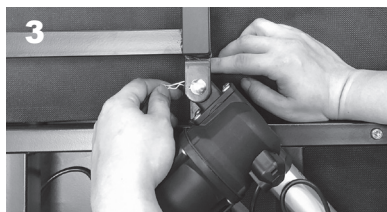
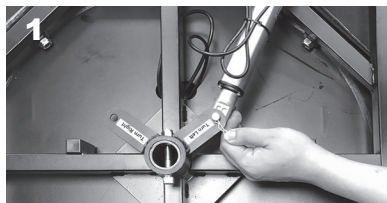

Installation Guide

CHANGING THE DIRECTION OF THE BED ROTATION (cont'd)

- 6 Adjust the stopper and the center rotation mechanism.
 - a. Rotate the center rotation mechanism slowly back towards the center.
 - b. When the stopper comes into contact with the metal support tubing, slide it from the Rotate Left position to the Rotate Right position.
 - c. Continue turning the center rotation mechanism at a necessary angle to fit the rotation motor.

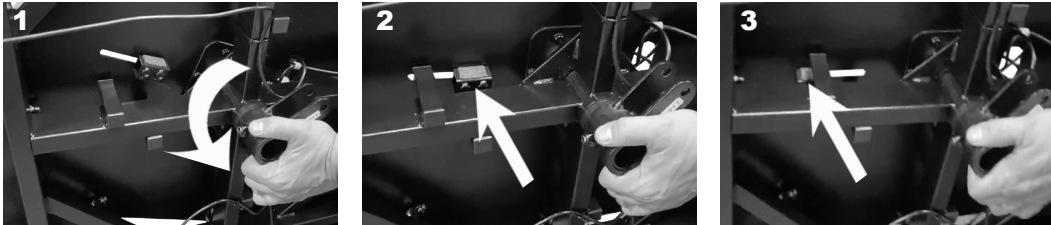

- 7 Transfer the rotation motor to the other side of the bed frame. Align both ends properly with the motor brackets on this side.



- 8 On one end of the motor, insert the motor pin back into the bracket and through the rotation motor. Insert the cotter pin to the end of the motor pin to secure it in place. Do the same on the other end of the rotation motor.

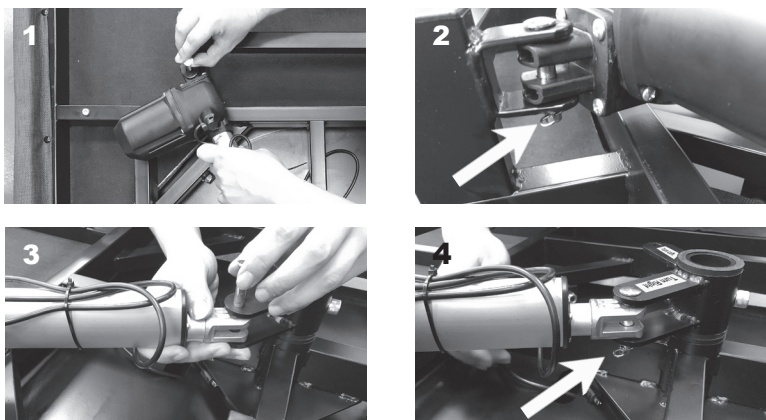

- 9 Turn the bottom part over carefully again, top side now facing up.
- 10 Make sure the stopper is moved all the way up to the "Turn Right" position. Tighten the screws using the Allen wrench to secure the stopper in place.

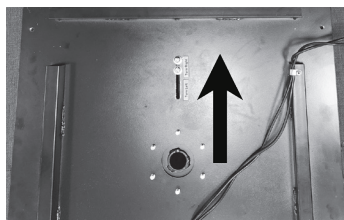

- 11 Place the top part of the Independence bed over the bottom part again. Do the rest of the steps on "Setting up your Independence bed" and "Setting up the electronics" again.

Your Independence bed now rotates to the right.

Installation Guide

INSTALLING THE ARMRESTS

- 1 Connect the two sections of the arm. Pull the spring release on the arm bracket as you insert the bracket into the arm.



- 2 Insert a bolt through the hole beside the spring release on the arm assembly. Thread a washer and nut at the end of the bolt. Tighten using a wrench and an Allen key wrench.
NOTE: Do not overtighten the nut so the armrest can rotate freely.

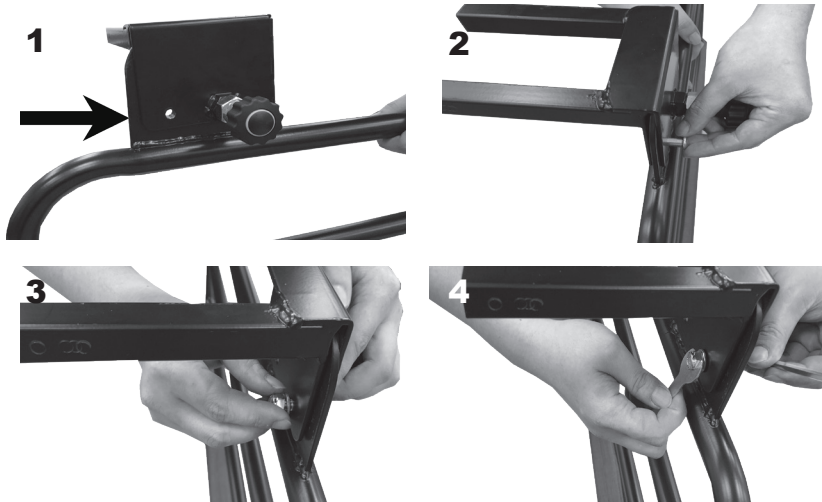

- 3 Insert the arm bracket into the open arm bars on the side of the bed.
- 4 Thread the knob screw into the bars and through the arm bracket to secure the armrest in place. Raise the head section of the bed, if needed to gain better access to the pre-drilled hole on the slot.
- 5 Repeat steps 1 to 4 to install the other armrest on the other side of the bed.

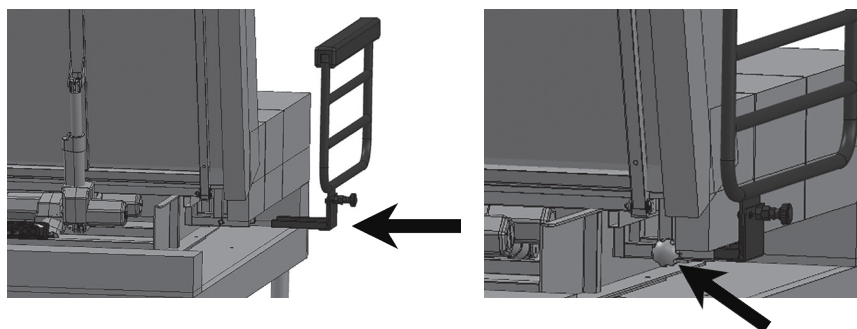

Installation Guide

6 To raise the armrest, do the following:

- a. Pull the spring release gently to unlock the armrest.
- b. While holding the spring release, rotate the armrest upward.
- c. Return the spring release. Make sure to insert it properly into its hole on the bracket to lock the armrest in place.

Repeat the steps to lower the armrest, rotating it downward into position.

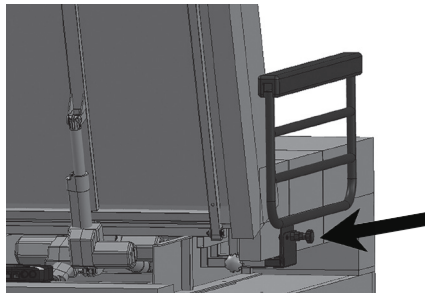

Pull the spring release gently to unlock the armrest.

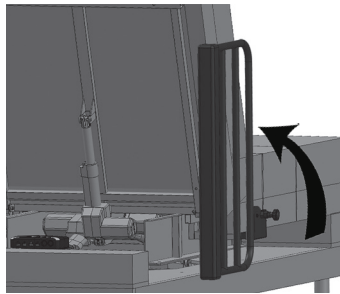

Once unlocked, the armrest can be raised or lowered easily.

Wired Remote Control Guide

BED MODES

Your Independence bed has four (4) different modes or positions. Depending on the mode, some buttons on your remote control may not function or cannot be used.

- **Bed Mode** - The Independence bed is in a flat position and is not rotated. The head and foot sections can be freely adjusted in this mode.
- **Rotate Mode** - The Independence bed has its head section halfway up and the foot section raised to its full height before it rotates.
- **Seating Mode** - The Independence bed is in an upright position with the head section up and the foot section down on the side like a chair. This usually follows the Rotate Mode.
- **Seat Up Mode** - The Independence bed is in an upright position and leaning a bit forward to assist you in standing up or getting off the bed. This usually follows the Seating Mode.

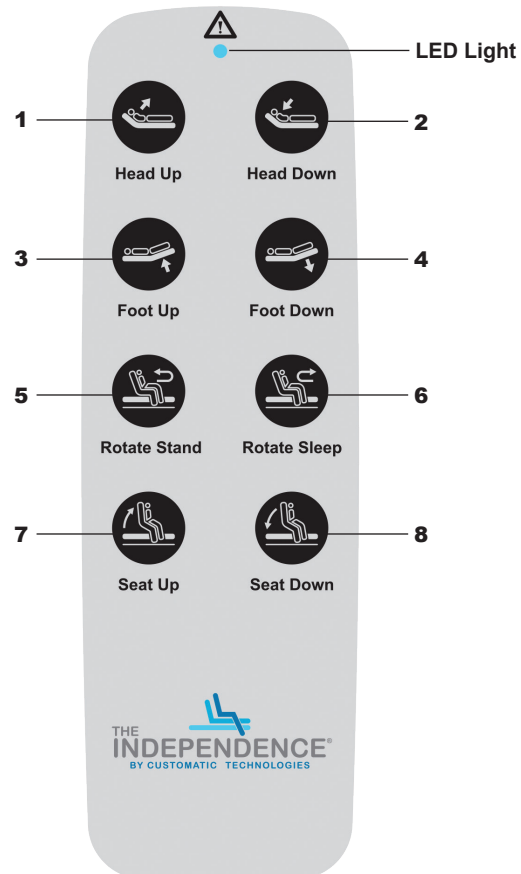

Wired Remote Control Guide

USING YOUR WIRED REMOTE CONTROL

Head Position Adjustments (1, 2)

- Press and hold these buttons to raise or lower the head section of the Independence bed.
- These buttons can be used only when the bed is in Bed Mode.

Foot Position Adjustments (3, 4)

- Press and hold these buttons to raise or lower the foot section of the Independence bed.
- These buttons can be used only when the bed is in Bed Mode.

Bed Rotation Adjustments (5, 6)

- Press and hold the **Rotate Stand** button to raise the head and foot sections and then rotate the Independence bed to the left or right, depending on your setup. This is the Rotate Mode.
- Press and hold the **Rotate Sleep** button to rotate the bed back into Bed Mode position.
- During Rotate Mode, only the Rotate Stand, Rotate Sleep, and Seat Up buttons can be used.
- These buttons cannot be used when the bed is in Seating Mode.

Seat Up Adjustment (7)

- Press and hold this button to move the head section of the Independence bed to lean forward, assisting you to stand up or get off the bed with ease. This is the Seat Up Mode.
- Press this button three (3) times quickly to automatically move the bed into the Seat Up Mode.
- This button can be used only when the bed is in Rotate or Seating Modes.

Seat Down Adjustment (8)

- Press and hold this button to move the seat back into a comfortable sitting position. This is the Seating Mode.
- Press this button three (3) times quickly to automatically return the Independence bed into a flat position. This is the Auto-Flat function.
- This button can be used only when the bed is in Rotate or Seating Modes.

RESETTING YOUR SYSTEM

Resetting the system is sometimes necessary to clear any error in the system or fix misalignment issues with the motors. For information on when to reset your system, see "Remote Control LED Error Codes" page 18.

- 1 Unplug the power cord from the outlet and then plug it back in.
- 2 On the remote control, press the **Seat Down** button three (3) times quickly.

This moves the bed into a flat position and resets the position and operation of the motors for safety.

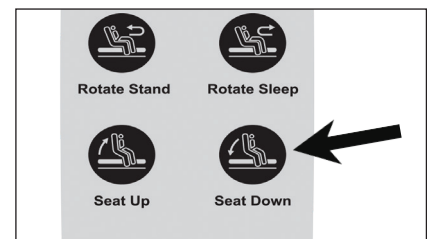

USING THE USB PORTS

Two (2) USB ports are conveniently located on each side of the Independence bed near the head section to provide easy access for charging your tech devices.

IMPORTANT! Be cautious and check the moving parts of the Independence bed while charging your devices using the USB ports.



USING THE UNDER BED LIGHT

Your Independence bed is equipped with under bed lighting to help you move in and out of the bed in a dimly lit room safely. It turns on automatically when the bed begins to rotate. It remains on for three (3) minutes and then shuts off.

Special Functions

ACTIVATING THE EMERGENCY POWER DOWN FEATURE

Your Independence bed supports the emergency power down feature when a power failure occurs.

NOTES:

- Install the 9V batteries in the power supply only during a power failure when the emergency power down function is needed.
- This feature is applicable only in Bed Mode. You can lower the head and foot sections into a flat position during a power failure.

- 1 Locate and remove the cover on the 9V battery compartment in the power supply unit.
- 2 Install the two (2) 9V batteries. Replace the battery cover.
- 3 After the 9V batteries are installed, press the **Seat Down** button on the wired remote control three (3) times quickly for the Independence bed to return to a flat position.

NOTE: The 9V batteries are for single use only. After lowering the Independence bed once during a power failure, replace with a new set of batteries.

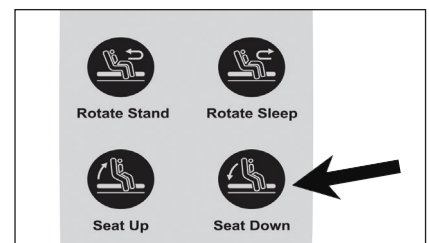

CONNECTING YOUR INDEPENDENCE BED TO A SMART DEVICE

Your Independence bed can be controlled using your iOS or Android smart device through the Independence mobile app.

Before connecting your Independence bed to the mobile app, do the following:

- Make sure your Independence bed is plugged into a working electrical outlet and the control box is on.
- Download and install the Independence mobile app from the App Store® or the Google Play™ Store.
- For iOS users, turn on your device's Bluetooth®. For Android users, turn on your device's Bluetooth® and Location settings.

- 1 If you are connecting your Independence bed to the mobile app for the first time, enable the mobile device pairing mode on your bed's control box.

Unplug the power cord from the outlet and then plug it back in. The LED light on the control box turns blue. After 20 seconds or after being operated by a paired remote control, the LED light turns green and the control box enters mobile device pairing mode.

NOTE: The control box stays in mobile device pairing mode for 60 seconds and the name of your Independence bed is now visible on the app.

- 2 From your mobile device, launch the app, and then tap the gear  icon to go to the Settings screen.
- 3 From the Devices list, select the name of your Independence bed.

NOTE: To find the name of your Independence bed from the Device list, look for the word "OKIN" followed by 6 numbers.



NOTES:

- If your Independence bed is not on the Devices list, make sure your Independence bed is in mobile device pairing mode. For information, see step 1.
- You can only connect one smart device to one Independence bed at a time.
- For more information on using the mobile app to control your Independence bed, see the Independence App Guide.

Troubleshooting

REMOTE CONTROL LED ERROR CODES

On normal conditions, the LED light on your remote control lights up only when a button is pressed. As a safety feature, this LED light may flash continuously to indicate any issues with the Independence bed. Check the LED light behavior below to troubleshoot issues with your bed correctly:

SYMPTOM

SOLUTIONS

LED light is blinking very fast.

The control box does not respond to any remote control commands. There may be an error or failure with the lift or rotation motors, one of which could be a poor connection.

1. Check that all the lift and rotation motors are plugged into the control box properly. Push the motor cables into the ports until you hear a *click*.
2. Unplug the power cord from the electrical outlet, and then plug it back in. The LED light blinks slowly.
NOTE: If the LED light continues to blink very fast after doing steps 1 and 2, contact our Customer Care Center.
3. Press the **Seat Down** button three (3) times quickly to reset the system. This moves the bed into a flat position and resets the position and operation of the motors for safety. The LED light stops blinking and your Independence bed can now be used.

LED light is blinking slowly.

The system needs to reset before operating the bed.

- Press the **Seat Down** button three (3) times quickly.

This moves the bed into a flat position and resets the position and operation of the motors for safety. The head and the foot sections raise up and then lower back down. The LED light stops blinking.

Troubleshooting

In the event the Independence bed fails to operate, investigate the symptoms and possible solutions below.

SYMPTOM

The Independence bed does not respond when the remote is used. The remote does not work.

No features or function of the Independence bed activates.

SOLUTIONS

- Check that the power cord is plugged into a working electrical outlet. Unplug the power cord from the outlet. After 30 seconds, plug it back in. The LED light on the remote control will blink slowly. Press the **Seat Down** button three (3) times quickly to reset the system. Press other buttons to check if they are working.
- Check that the surge protection device or electrical outlet is not defective. Test the outlet by plugging in another working appliance.
- Check if the control box is working properly. Make sure the control box is properly connected to the power supply unit by checking if the LED light turns on when the power cord is plugged in.
- Check if both the wired remote control and control box are receiving power and are functional. Make sure the LED light on the remote control lights up when a button is pressed and the LED light on the control box is on and steady.

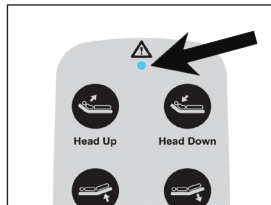

Head or foot section elevates Independence bed but does not return to flat position.

- Your Independence bed may be obstructed preventing smooth operation. Remove obstructions from around and under the bed.
- Check that the head section is not too close to the wall.

Head or foot lift function has minor interference during operation.

- Make sure that you are following the duty cycle of the motors. Do not operate for more than two minutes over a 20-minute period or approximately 10% duty cycle.
- Press the lift buttons firmly and accurately.
- Remote control may be experiencing common radio frequency interference from other radio transmitting devices. Wait several seconds and then try pressing the lift buttons again.

Troubleshooting

In the event the Independence bed fails to operate, investigate the symptoms and possible solutions below.

SYMPTOM	SOLUTIONS
A clicking noise is heard under the bed when raising or lowering the sections.	This is normal. The lift motors click when they are engaged. No action is required.
The Independence bed is squeaking.	<ol style="list-style-type: none">1. Remove any pin, nut, bolt, or white bushing one at a time.2. Lubricate it by applying the grease with a cotton swab. Using a lithium or spray lubricant is recommended. (Lubrication can be obtained by contacting Customatic's Customer Care Center).3. When placing the lubricated pin, nut, bolt, or white bushing back onto the Independence bed, make sure there is a looser tightening on the nut.4. Additional solution: After completing these steps, spray the pins, nuts, bolts, and white bushings with a lubricant.
The Independence bed stutters when in motion.	<ul style="list-style-type: none">• Clear any clutter or obstructions under and around the Independence bed. Radio frequency interference from other remotes or electronic devices may affect normal operation.• Press the lift buttons on the remote control firmly and accurately.

Warranty and Registration

LIMITED WARRANTY

LIMITED WARRANTY: Subject to the terms and conditions set forth herein, the manufacturer of this product, PPJ, LLC (“Customatic®”) warrants to the original retail purchaser for the time periods stated herein that the Independence® Bed system purchased from an authorized reseller of genuine Customatic® products is merchantable and free of defects and materials and is fit for the purpose of residential, non-hospital bedding. This warranty applies only to genuine Customatic® products, and without limiting the foregoing, does not apply to power cords or other accessories supplied by the seller or other parties.

2-Year Period for Labor: During the first 2 years of an applicable warranty period, labor for warranty repairs will be provided at no cost to the consumer. After that period, unless otherwise agreed in writing by Customatic®, costs of labor for warranty service and repairs will be the consumer’s responsibility.

2-Year Period for All Components: The warranty period is 2 years for the bed frame, all components and parts, including, without limitation, electronics, electrical components, drive motors, WiFi module, power supply and power cords, and massage motors.

10-Year Period for Bed Frame: The warranty period is 10 Years, prorated for the bed frame, defined as follows: the metal structure of the Independence® bed system only, and specifically does not include its cover, side rails, decking or legs, or other attachments thereto, such as actuator lift motors, control box, WiFi modules, power supply, power cords, control box or other electrical or mechanical components. For years 3 through 10, the warranty will be reduced by one-eighth (1/8) for each year beyond the second year.

10-Year Warranty Period for Foam Mattress: The foam mattress and cover are warranted against defects in material and workmanship for a period of 10 years under normal use.

Our warranties do not cover transportation and inspection costs; height of mattress; stains, soiling, fluid penetration, tears or burns; comfort preference; and recovery time of memory foam.

Start of Warranty Period: The warranty periods stated above will commence on the date of the first retail purchase of the Independence® Bed system from an authorized Customatic® reseller, provided that proof of purchase and warranty registration occur within the time and in the manner set forth below. In the case of replacement parts provided by Customatic, the warranty will apply to the original warranty period and will not extend beyond such period.

IMPLIED WARRANTY DURATION: All applicable warranties implied by law shall be limited in duration to the respective time periods stated below for express warranties of particular components.

EXCLUSIONS FROM WARRANTY: Loss, damage, malfunctions or other defects caused in whole or in part by any one or more of the following are not covered by any warranty and neither Customatic nor the seller shall be responsible for them: ordinary wear and tear; damage not directly caused by a defect covered by this express warranty; failure to comply with this user Manual and/or any other user instructions issued by Customatic for use and maintenance, including without limitation, weight limits and operation; modifications not performed by Customatic; use of any parts, components, or accessories that are not supplied by Customatic for the specific product and installed by an authorized Customatic service provider; use of the product for purposes or in a manner not expressly intended by Customatic as described in this Manual or any other misuse or abuse; storage or use outside of home or other exposure to the elements; dampness; or transportation or other handling by anyone other than Customatic.

EXCLUSIVE LIMITED REMEDY: The sole and exclusive remedy for any item which fails to conform to warranty shall be, at Customatic’s option, either repair or replacement of the defective item. Customatic may require reasonable evidence of the existence of a defect, and Customatic customer service staff will discuss specific requirements with the purchaser based on the defects identified by the purchaser. Replacement parts will be provided at no cost to the purchaser, provided that the defective parts are delivered to Customatic, unless Customatic instructs otherwise in the claims process (see below). Subject to advance approval by Customatic, it will also pay reasonable shipping costs for returns requested by

Warranty and Registration



WARRANTY REGISTRATION FORM

SURVEY

NAME _____
PHONE _____
ADDRESS _____
CITY _____
STATE _____ ZIP CODE _____
EMAIL ADDRESS _____
STORE WHERE PURCHASED _____
SERIAL NO. _____
INVOICE NO. _____
MODEL NO. _____

GENDER: M F
AGE: 18-30 31-40 41-50
 51-60 61-70 71 & up
Reason for purchasing an Independence bed:
 Health Comfort Other
How did you find out about our beds?
 Advertising A friend
 Store Article
 Internet Other

Fill out online at TheIndependenceBed.com or mail to:
Independence Beds, Inc.
P.O. Box 5929, Virginia Beach, VA 23471

Customatic and replacement parts or bedding systems.

CLAIMS PROCESS: Prior to contacting Customatic, please refer to the TROUBLESHOOTING section of this Manual and also ensure that use and maintenance instructions in this Manual have been followed. ***The following process must be followed to initiate a warranty claim:*** (1) during the applicable warranty period stated above, contact Customatic customer service to initiate the claim and provide proof of status as the original retail purchaser from an authorized Customatic® products reseller and prior timely registration of the product (see PRODUCT REGISTRATION below); (2) identification of suspected defect and compliance with Customatic requests for documentation or other evidence of the defect, such as return of parts to Customatic, the cost of

which will be paid by Customatic if the defect is confirmed by it or inspection by an authorized Customatic service technician or other person approved in writing for that purpose by Customatic; and (3) remedy by Customatic as stated herein.

LIMITATION OF LIABILITY: In no event shall Customatic be liable for incidental or consequential damages of any kind or nature whatsoever caused by or arising out of any product defects, and the sole and exclusive remedy shall be repair or replacement of defective items within warranty to the extent and in the manner provided herein.



IF YOU EXPERIENCE ANY TROUBLE WITH YOUR INDEPENDENCE BED WITHIN THE WARRANTY PERIOD, PLEASE CONSULT THE TROUBLESHOOTING GUIDE PROVIDED WITH YOUR BED AND ONLINE, IF APPLICABLE. IF PROBLEMS PERSIST, PLEASE CALL:

CUSTOMER CARE CENTER

1 (844) 815 9023

TheIndependenceBed.com